

Schablone Blatt ①

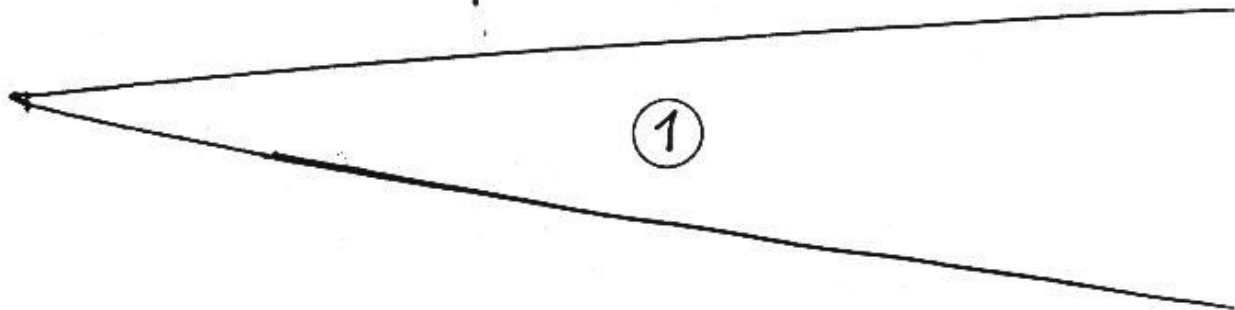

27.03.02 GERTH
GER 48

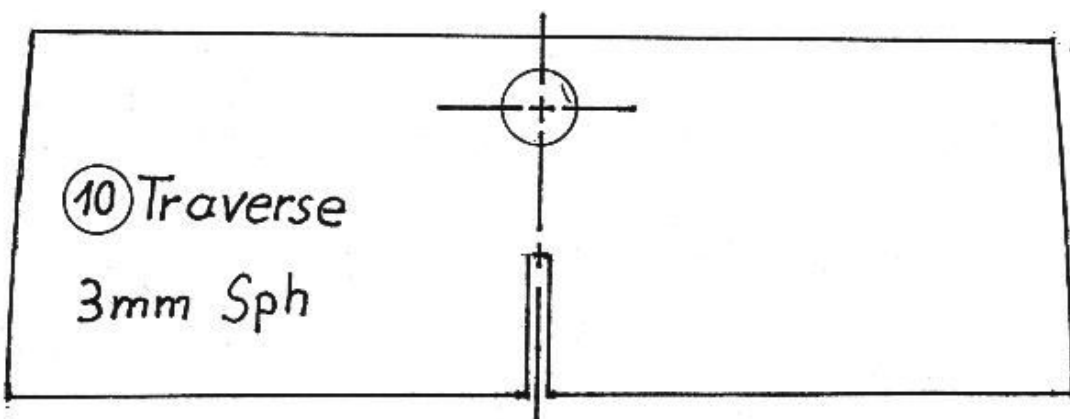
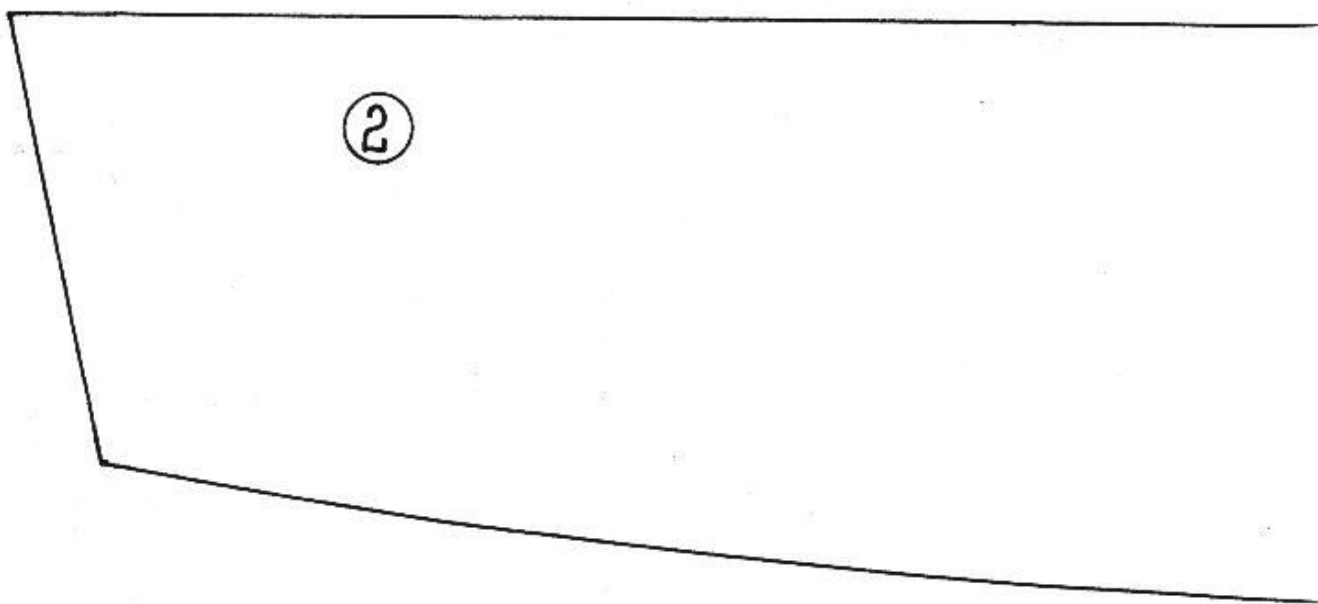

Maßstab

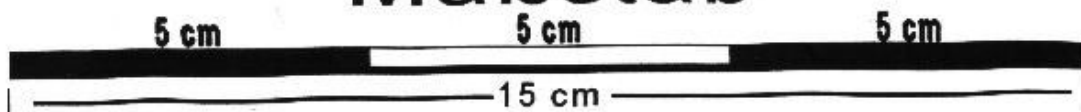

Schablone Blatt (2)



27.03.02 GER/14
GER 48

hier Blatt 1 aufkleben

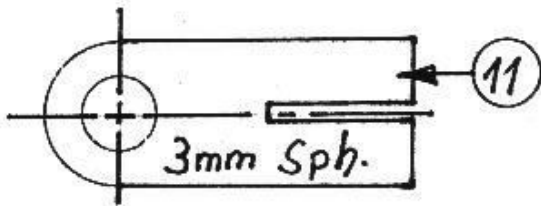

Maßstab

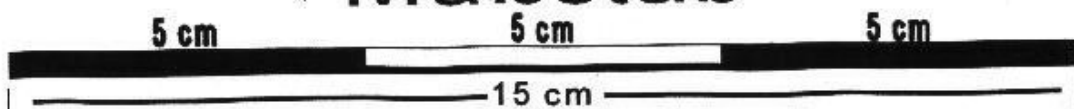

Schablone Blatt ③



27.03.02 GERH
GER48

② Bordwand
2 x ausschneiden

hier Batt 2 aufkleben

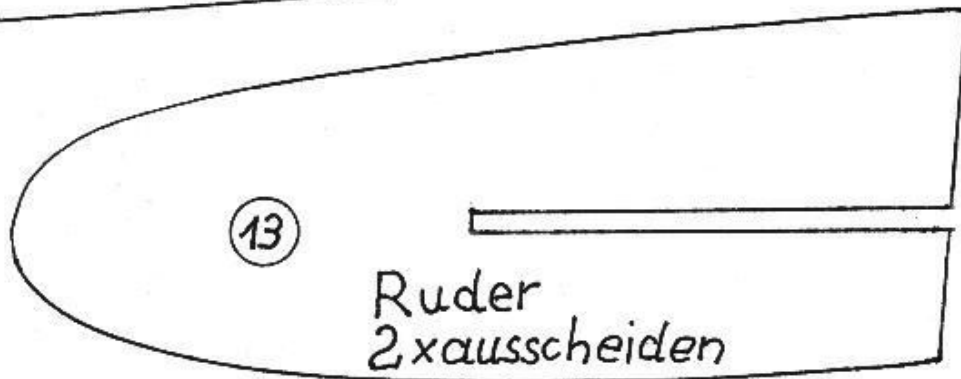

Bodenplatte

① 2 x ausschneiden

Maßstab

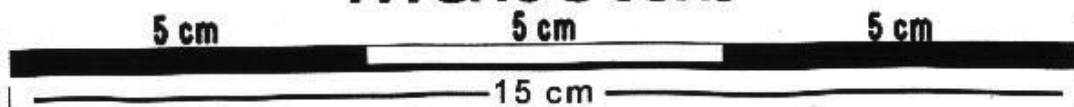

Schablone Blatt ④



27.03.02 GER/H
GER 48

hier Blatt 3 aufkleben

②

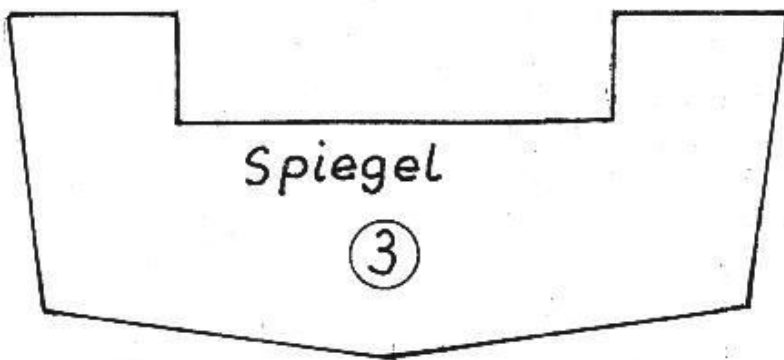

Spiegel

③

①

Maßstab

